



## Content

1. **Sample storage in drug discovery, diagnostics and basic research**
  - 1.1 Microplates for automated sample storage
  - 1.2 Chemical characteristics of polypropylene
  - 1.3 Microplates for compound management
  - 1.4 Concept of direct compound transfer
2. **Development of a new storage plate supporting assay miniaturisation in high-throughput screening**
  - 2.1 Determining the best well geometry
  - 2.2 Performance of the 384 Deep Well Small Volume™ plate for pre-dilutions
  - 2.3 Use of 384 Deep Well Small Volume™ microplate in existing high-throughput screening systems
3. **Heat Sealing**
  - 3.1 Heat sealing parameters and their influence on sealing properties
4. **Ordering Information**

## A New 384 Well Storage Plate Reducing Compound Consumption and Supporting Assay Miniaturisation

### 1. Sample storage in drug discovery, diagnostics and basic research

Reliable sample storage and retrieval is a vital function to drug discovery as well as basic research and diagnostics. Coordination and distribution of samples and compounds is the initial step in a cascade of subsequent actions within an experiment. Errors in sample distribution, many of which are difficult to trace, frequently lead to inaccurate or misleading experimental results. Trouble-shooting the root cause of inaccurate data can be very time-consuming and therefore linked with high costs.

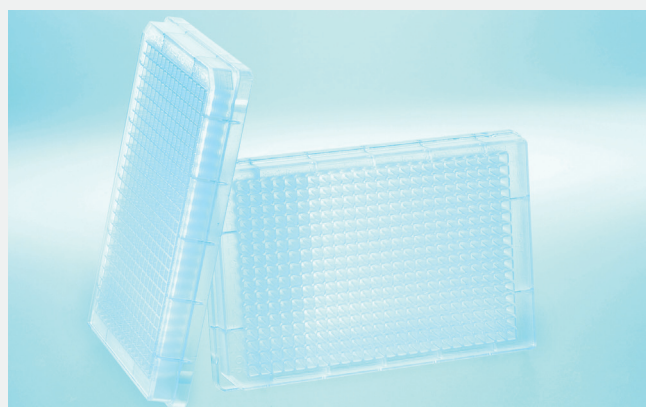

Figure 1: 384 Deep Well Small Volume™ polypropylene microplate from Greiner Bio-One

For storage of a relatively small number of samples, storage tubes and box systems with handwritten labels are frequently used. In these systems tubes are customarily labelled with indelible ink, however, the small writing area severely limits the amount of information which can be contained on the tube, and the stability of the label is not guaranteed (Fig. 2). Because of these disadvantages, use of hand-labelled storage systems often results in non-identifiable samples, confusion and loss. For this reason, systematic storage systems have become increasingly popular, even in basic research laboratories.



Figure 2: Example for storage of samples in basic research. The samples are stored in labelled polypropylene tubes in paperboard boxes at  $-20^{\circ}\text{C}$  or  $-80^{\circ}\text{C}$ . The amount of information written on the tube is limited. An organised storage structure is difficult to achieve.



Figure 3: Cryo.s™ tubes with Datamatrix for cryogenic sample storage and secure and efficient sample identification.

A new and innovative sample management system is the use of cryogenic conservation tubes labelled with laser-printed 2D barcodes. This system allows tube storage in boxes (Fig. 3), but with significant improvement in the amount of printed information that can be contained on the tubes.

Printed 2D barcodes are highly resistant against many solvents used in the laboratory and do not smudge or blur. The integrity of the code will remain unchanged throughout the life span of the tube. Together with simple personal computer based data management systems and commercially available 2D barcode readers, 2D barcoded tubes provide a safe and reliable storage system for basic research, diagnostics and smaller drug discovery groups (further information: Greiner Bio-One Forum No. 10, Datamatrix Coding).

### 1.1 Microplates for automated sample storage

With the increase of throughput, a sophisticated solution with automation is mandatory. Microplates are frequently the tool of choice for automated sample storage (Fig. 4). Due to the efforts of the Microplate Standards Development Committee of the Society for Biomolecular Sciences, primary microplate dimensions (e.g., length, width and height) and tolerances are now standardised according to the American National Standards Institute (ANSI), which facilitates automation (for more information see: <http://www.sbsonline.com/msdc/approved.php>).

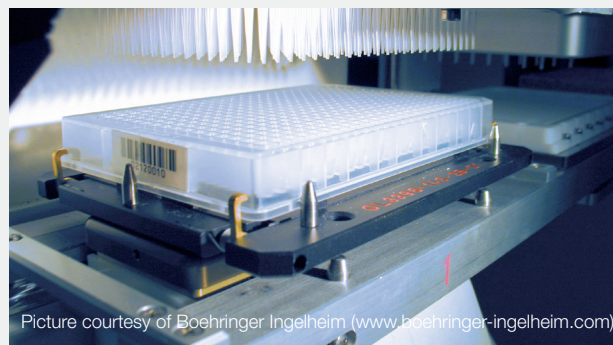

Picture courtesy of Boehringer Ingelheim ([www.boehringer-ingelheim.com](http://www.boehringer-ingelheim.com))

Figure 4: Barcoded storage microplate in a high-throughput screening environment.

### 1.2 Chemical characteristics of polypropylene

Most storage microplates are manufactured of polypropylene (Fig. 5).

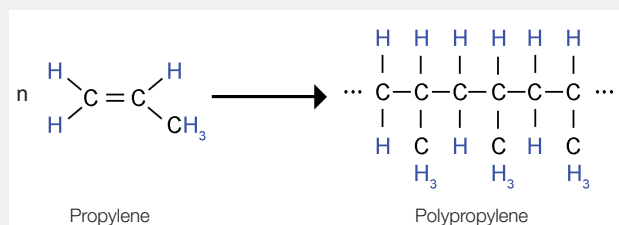

Figure 5: Chemical structure of polypropylene and its monomer propylene.

Polypropylene (PP) has low biomolecular binding characteristics (Fig. 7), high temperature tolerance and high resistance against many solvents such as DMSO (Table 1). Polypropylene can also easily be heat-sealed, a major request in high-throughput screening where heat sealing is the most common way to close a microplate.

Table 1: Chemical resistance of polypropylene.

	PP 20°C	PP 50°C
Acetone	1	3
Acetonitrile	3	4
Chloroform (CHCl3)	3	4
Cyclohexanol	1	3
Detergents	1	1
Dimethylsulfoxide (DMSO)	1	1
Ethanol 96%	1	1
Hexanol	1	-
Isobutanol	1	1
Isopropanol	1	1
Methanol	1	1
Phenol (100 %)	1	1
Sulfuric Acid 60%	1	3
Tetrachlormethane	4	4

1 = resistant, 2 = limited resistant, 3 = moderate resistant, 4 = no resistance  
 This is a general guide only. As many factors can affect the chemical resistance of a given product, its suitability for a specific application should be tested. For more detailed information about chemical resistance of different raw materials please visit our website: [www.gbo.com/bioscience/technical\\_information](http://www.gbo.com/bioscience/technical_information)

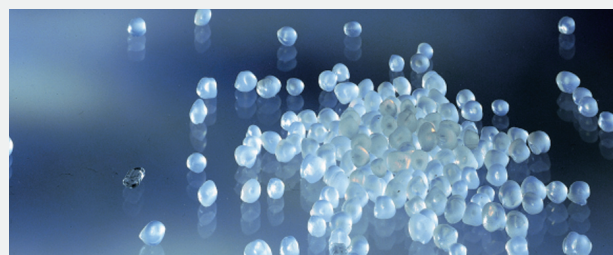

Figure 6: Polypropylene resin

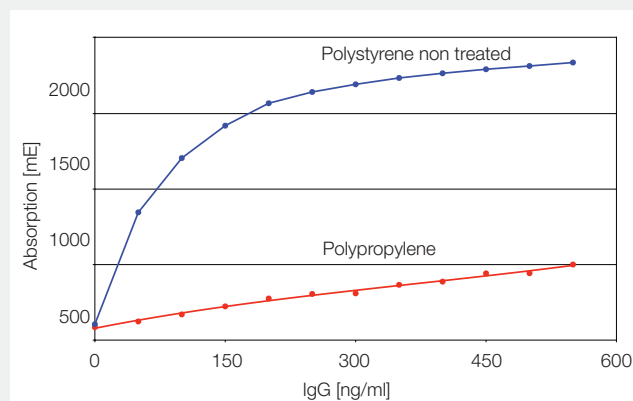

Figure 7: Binding of human IgG to polystyrene and polypropylene.

### 1.3. Microplates for compound management

A large variety of 96 well and 384 well storage microplates are commercially available. 96 well microplates are widely used in research or diagnostics, whereas drug discovery is more focused on miniaturisation, and 384 well or even 1536 well microplates are frequently applied for the storage of compound solutions. Microplates with different well designs are available for these formats (Fig. 8).

For many years microplates with conical V-shaped wells (Fig. 9) were preferred in high-throughput screening, as it was generally assumed this design enabled better pipetting with all sample collected in a central location at the well bottom.

With increasing popularity of direct compound transfer, the classical F- and V- bottom well designs (Fig. 9) do not fulfill all requirements of new compound management technologies. It is especially difficult to precisely position pin tools or pipette tips for reliable access of low sample volumes, resulting in loss of valuable sample material.

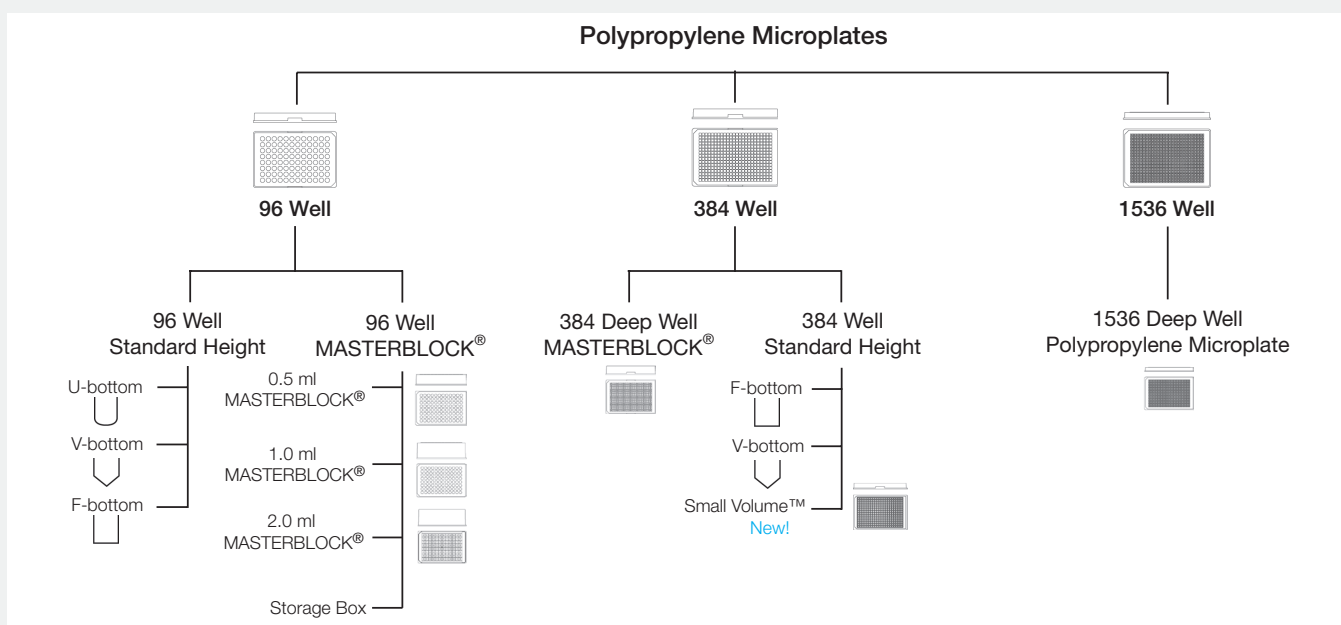

Figure 8: Selection of available polypropylene microplates.

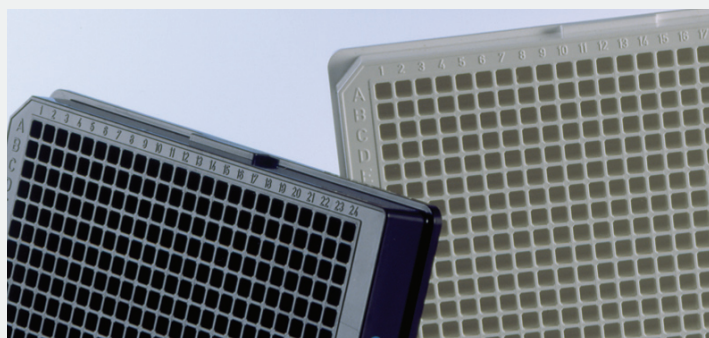
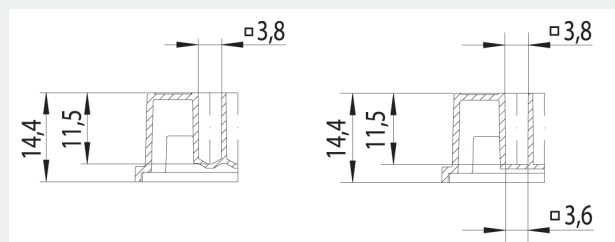

Figure 9: V- and F-bottom well design: The V stands for a conically tapered well whereas F stands for a flat bottom well.



Well profile: 384 well V-bottom, polypropylene  
 Total volume: 130 µl  
 Working volume: 13-120 µl

Well profile: 384 well F-bottom, polypropylene  
 Total volume: 152 µl  
 Working volume: 15-145 µl



### 1.4 Concept of direct compound transfer

In direct compound transfer (Fig. 10) very low volumes of compound solutions are transferred from a source plate directly into an assay plate without any intermediate dilution steps. The compounds are then diluted to the desired final concentration by adding or pre-dispensing assay buffer and reagents.

Direct compound transfer (Fig. 10) saves labor and costs with elimination of redundant intermediate dilution steps. Furthermore, minimising dilution steps additionally reduces the risk of compound precipitation. Because non diluted compounds are often in scarce supply, a low dead volume of the storage microplate is highly desirable to achieve complete sample retrieval with minimal waste.

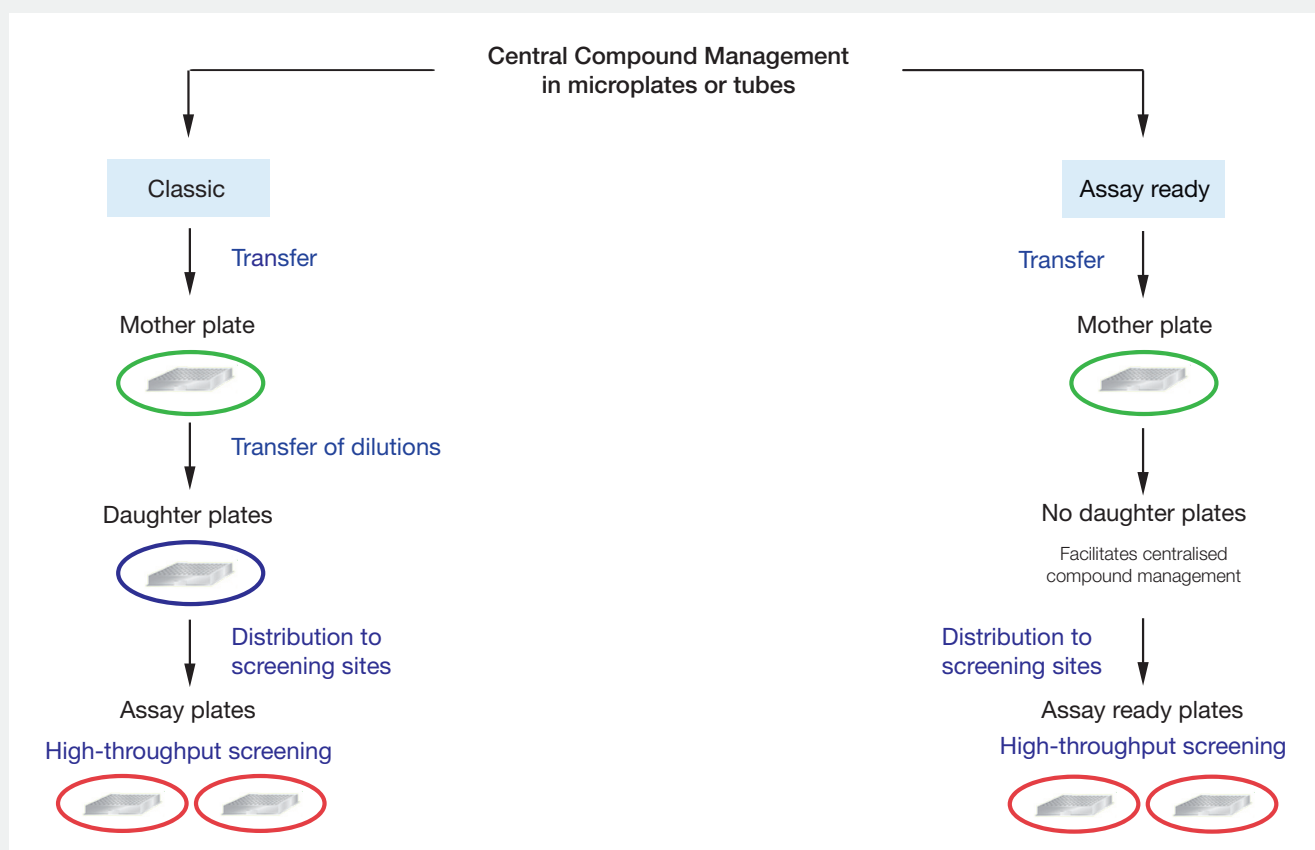

Figure 10: Example of a direct compound transfer approach in comparison to a classic approach with diluted compounds.

Direct compound transfer can be performed either with pin tools (Fig. 11) or with acoustic liquid handling systems. Acoustic liquid handling enables the transfer of very small amounts of compounds down to 1 nL, but requires expensive technical equipment, whereas pin tools are much easier and less costly to implement in existing high-throughput screening environments and allow the liquid transfer of approximately 50 nL.

Additionally, acoustic liquid handling systems require specialised microplates, while pin tools can be employed with all kind of existing storage microplates. However, a disadvantage of pin tools is that they may be sensitive to an uneven liquid distribution in standard V- and F-bottom microplates, leading to loss of valuable compounds.

To overcome the drawback of conventional polypropylene storage microplates a new well geometry (Fig. 12) was developed in cooperation with the Compound Management and HTS groups of Boehringer Ingelheim (Biberach, Germany). The resulting 384 Deep Well Small Volume™ microplate was designed to allow perfected positioning for small sample volumes with pin tools or pipette tips and facilitate direct transfer from storage to assay plates without need for expensive devices.



Picture courtesy of Cybio AG ([www.cybio-ag.com](http://www.cybio-ag.com))

Figure 11: Low Dead Volume Liquid Handling / Capillary Head for CyBi®-Well vario.

- Simple and robust
- Aspiration by capillary effect
- Calibrated capillaries with fixed volumes
- Dispensing by pressure impulse / air pressure
- Simultaneous transfer of 96 or 384 samples
- Low dead Volume (< 1 µL)

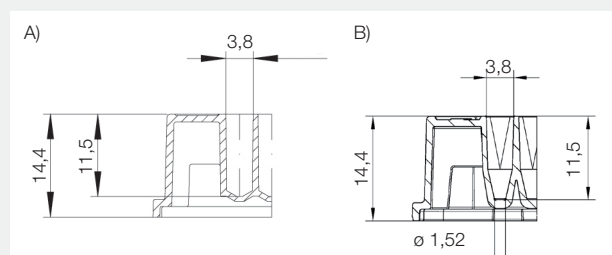

Figure 12: Well Geometry of a standard V-bottom (A) well and well geometry of the new 384 Deep Well Small Volume™ microplate (B).

## 2. Development of a new storage plate supporting assay miniaturisation in high-throughput screening

### 2.1 Determining the best well geometry

During initial development a technical specification for the well geometry of the new microplate was postulated:

- The positioning of small sample volumes must be precisely focused in the well cone so that the sample can be easily transferred by pin tools or pipette tips.
- The plate must follow the most important ANSI recommendations (length, width, height, bowing) to be compatible with robotic liquid handling systems and common microplate handling processes (e.g. heat sealing, piercing, stacking).
- The wells must have a maximal volume of approximately 100  $\mu\text{l}$  to enable pre-dilution of samples.

To determine the optimal well cone geometry a hybrid prototype microplate with three different cone geometries was designed (Fig. 13).

- Design 1: conical well with a round bottom
- Design 2: conical well with a flat bottom
- Design 3: blunt cone with a round bottom



Figure 13: Different Well Geometries.  
A) Conical well with round bottom  
B) Conical well with flat bottom  
C) Blunt cone with a round bottom

The resulting hybrid test plate was evaluated in practical tests. The wells were tested with 50 nl and 100 nl pin tools by the HTS group of Boehringer Ingelheim in Biberach according to the following procedure:

- Filling of the plate with 1  $\mu\text{l}$  and 2  $\mu\text{l}$  DMSO Orange G solution, respectively (Flexdrop, Perkin Elmer, Waltham-Massachusetts)
- Visual control and centrifugation
- Transfer with 50 nl and 100 nl pin tools into an assay plate (20/40  $\mu\text{l}$  aqueous buffer solution, V&P Scientific)
- Validation of the transfer precision by absorption measurement (TECAN Ultra)

The results of the first tests were:

- Design 1 showed splashing with some pipetting devices.
- Pin tools can be damaged with design 3 if they touch the well wall.
- Design 2 showed the best performance in liquid transfer (Table 2).
- The flat well bottom of design 2 was easily accessible in contrast to the standard V-bottom design (Fig. 16).
- The flat bottom slightly reduced the liquid height for volumes below 1  $\mu\text{l}$  but concentrated the sample in the well cone (Fig. 14).

Table 2: Pin tool liquid transfer from different wells.

			Design 1	Design 2	Design 3
50 nl pin tool	from 1 $\mu$ l into 20 $\mu$ l	CV [%]	6.410	2.982	4.480
		Min [OD]	0.384	0.528	0.487
		Max [OD]	0.618	0.616	0.601
		Vol. [nl]	53	53	51
	from 2 $\mu$ l into 20 $\mu$ l	CV [%]	4.533	2.849	5.209
		Min [OD]	0.523	0.577	0.508
		Max [OD]	0.675	0.660	0.679
		Vol. [nl]	58	58	58
100 nl pin tool	from 2 $\mu$ l into 40 $\mu$ l	CV [%]	3.075	3.895	3.310
		Min [OD]	1.088	1.095	1.025
		Max [OD]	1.246	1.253	1.211
		Vol. [nl]	106	108	101
	from 1 $\mu$ l into 40 $\mu$ l	CV [%]	5.501	5.726	4.789
		Min [OD]	0.952	0.905	0.787
		Max [OD]	1.152	1.148	1.098
		Vol. [nl]	95	96	90

Data courtesy of Boehringer Ingelheim (www.boehringer-ingelheim.com)

Volume [ $\mu$ l]:	0.5 $\mu$ l	1.0 $\mu$ l	2.0 $\mu$ l	4.0 $\mu$ l
Competitor 384 well PP microplate				
Liquid height [mm]	0.6 mm	0.8 mm	1.0 mm	1.25 mm
384 Deep Well Small Volume™ storage plate from Greiner Bio-One (# 784 201) Focused sample				
Liquid height [mm]	0.3 mm	0.5 mm	0.9 mm	1.5 mm

Figure 14: Liquid height depending to well volume.

Further tests with colored DMSO solution demonstrated that the remaining liquid, e.g. compounds in DMSO, aggregate in the well bottoms of design 2, whereas the liquid within standard V-bottom wells tended to spread out (Fig 15). Furthermore the liquid height level increased at a faster rate in design 2 in comparison to the classical V bottom well (Fig. 14). With the combination of a clearly focused access for pin tools (Fig. 16), sufficient tolerances to avoid crashes and limited space to avoid liquid distribution, well design 2 allowed a precise direct compound transfer for the postulated specification criteria. In summary, design 2 exhibited the best performance and was therefore selected as the basis for the new well design.

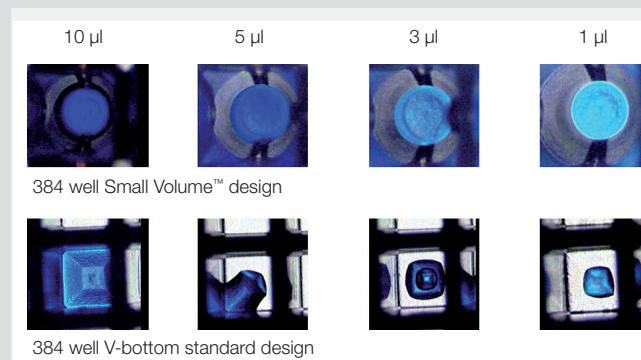

Figure 15: Location of liquid at the bottom of the new well in comparison to a standard V-bottom well.

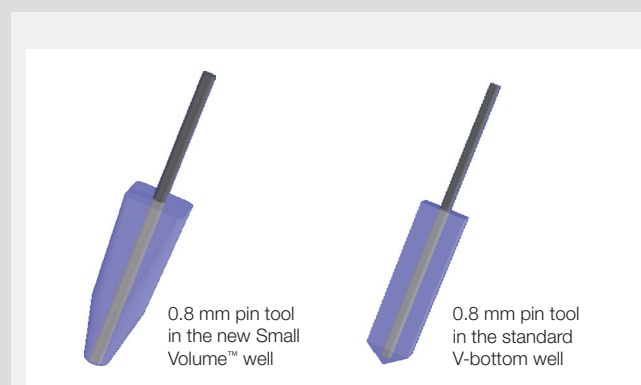

Figure 16: Positioning of pin tools.



## 2.2 Performance of the 384 Deep Well Small Volume™ plate for pre-dilutions

Despite advantages of direct compound transfer, many assays still require a classic approach with pre-diluted compound solutions. Although the preparation of diluted compounds facilitates homogenous mixing of compounds with assay buffer, direct compound transfers may not be the best method for cell based assays. This especially because adherent cells can react sensitively when placed in direct contact with undiluted, highly concentrated compounds dissolved in 100 % DMSO. Furthermore, studies have not yet completely examined the behavior of compounds when stored at very low volumes for long time periods in assay microplates. Open questions remain as to evaporation, compound solubility, and binding of compounds to the microplate surface.

Another major requirement of the new well design was a maximal volume of approximately 100  $\mu\text{l}$  to enable pre-dilution of samples. To achieve the specified total volume the well cone was combined with a square well geometry at the top (Fig. 17 A), resulting in a final working volume of 1- 90  $\mu\text{l}$  and a maximal volume of 107  $\mu\text{l}$  (Fig. 17 B).

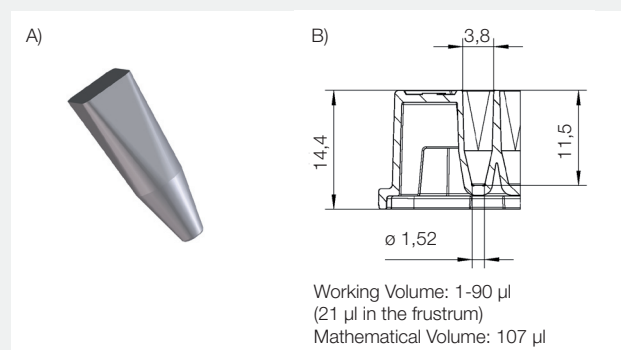

Figure 17: Shape of the new well design.

## 2.3 Use of the 384 Deep Well Small Volume™ plate in existing high-throughput screening systems

The outer dimensions and the height of the microplate are following the ANSI recommendations (Fig 18 / ANSI-SBS1-2004, ANSI-SBS2-2004). The depth of the well is similar to well depth in a standard Greiner F-bottom or V-bottom microplate, thereby avoiding a time consuming adaption in the automation process. Relevant product information (technical drawing, data sheet) is available on our website ([www.gbo.com/bioscience](http://www.gbo.com/bioscience)) in our online shop.

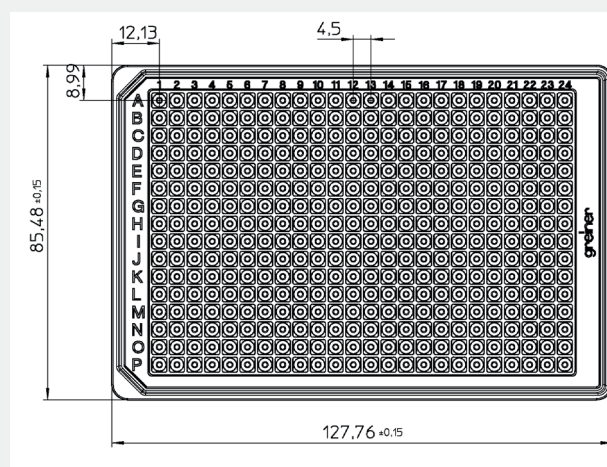

Figure 18: Microplate dimension of the new 384 Deep Well Small Volume™ microplate.

### 3. Heat sealing

Another major requirement for the new microplate design was compatibility with heat sealing. Heat sealing is the most widespread applied technology for closing compound storage microplates. Heat seals are temperature and DMSO resistant and chemically inert.

Most heat sealing devices available on the market work in a similar manner. A polypropylene coated film, either a transparent plastic film or an aluminum foil, is "ironed" onto the microplate surface.

To enable a tight heat seal the new 384 Deep Well Small Volume™ microplate provides a sufficiently pronounced rim of 0.5 mm and is characterised by tight tolerances to improve its sealing properties.

No matter which device is used, for a tight and non destructive sealing the right settings must be evaluated carefully before the onset of routine work. Each microplate design needs special adjustments of the heat sealing parameters (temperature, time and pressure) due to the influence of wall thickness, well design and raw material on heat sealing properties.

#### 3.1 Heat sealing parameters and their influence on sealing properties

##### 1) Temperature / Time

It is recommended to limit the sealing time as much as possible. Higher temperatures with a shorter sealing time will generally yield a better result (less warpage) than a longer sealing time with lower sealing temperatures.

##### 2) Influence of polypropylene

The polypropylene resin used for microplate manufacture can influence its sealing properties. Microplates manufactured of polypropylene with a high melting point require stricter settings (higher temperature, longer sealing time) than microplates manufactured from lower melting point polypropylene.

Storage microplates from Greiner Bio-One are generally manufactured from the same type of raw material, which facilitates the transfer of existing heat sealing settings.

##### 3) Plate height

The adjustment of the heat sealing device to the individual microplate height is essential for a reliable sealing process. Inaccurate height settings can lead to a distorted microplate surface or incomplete heat sealing (Fig. 19). All Greiner Bio-One 384 well standard volume polypropylene microplates have a height of 14.4 mm (ANSI/SBS2-2004 Height Dimensions) which facilitates the setup of heat sealing processes.

##### 4) Adapters

Most suppliers of heat sealing systems offer adapters that support the centre of the microplate. Adapters are advantageous to distribute pressure, thereby reducing the potential for warpage and heat distortion of the sealed microplate.

##### 5) Pressure

Pressure is not generally defined as an adjustable parameter. However, pressure may have an influence on the sealing of the microplates as well.

For detailed technical support please contact the supplier of the heat sealing device.

##### 6) Multiple heat sealing

Multiple heat sealing offers an advantage in that microplates can be opened and closed several times for compound sampling, however it should be noted that each heat sealing step translates to a stress for both the microplate and the material it is manufactured of. Therefore multiple heat sealings are not recommended, as multiple heat-sealed microplates often demonstrate warpage and deformation. The resulting microplate geometry, tolerances and dimensions will not fulfill the tight specifications necessary for hassle free high-throughput screening.

As an alternative to multiple heat sealings, remaining compounds should be transferred into separate microplates or the concept of compound storage based on sealing with a lid should be selected (M. Pfeiffer, G. Scheel, Journal of Biomolecular Screening 2009, 14 492-498).

Table 3 provides a general overview for heat sealing the new 384 Deep Well Small Volume™ microplate (# 784 201)\*.

Table 3: General guideline for heat sealing settings in a Remp (Remp AG, Oberdiessbach, Switzerland), Velocity11 PlateLoc® (Velocity11 Automation Solutions, Santa Clara, CA USA) and ABGene ALP 300 (ABGene, Epsom, UK) for the 384 Deep Well Small Volume™ (# 784 201).

Device	Temp.	Time	Pressure <sup>(x)</sup> Adapters	Result
Remp Portrait Heat Sealer	168°C	2 sec	Adapter	Plate completely sealed, no heat distortion and warpage minimised. Sealing Device should be adjusted to the plates height of 14.4 mm in order to avoid high sealing pressure
Velocity11 PlateLoc®	164°C	2 sec	81 PSI	Plate completely sealed, no heat distortion and warpage minimised. Several adapters supplied from Velocity can improve the sealing results
Velocity11 PlateLoc®	170°C	1 sec	81 PSI	Alternative PlateLoc® setting: Plate completely sealed, no heat distortion and warpage minimised. Several adapters supplied from Velocity can improve the sealing results
ABGene ALPS 300	172°C	1 sec	Adapter	Plate completely sealed / No heat distortion / Warpage minimised

\* This information is a general guide only. As many factors can affect the sealing setting, suitability for a specific application should be tested.

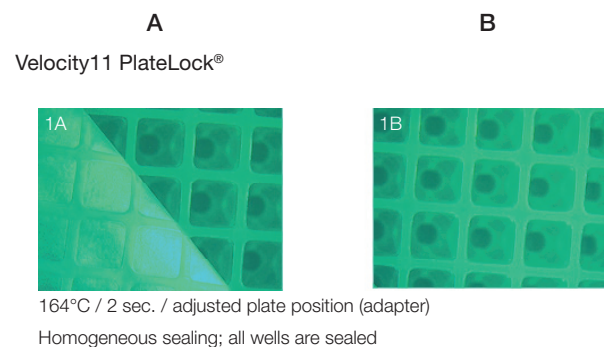

#### Remp Heat Sealing System

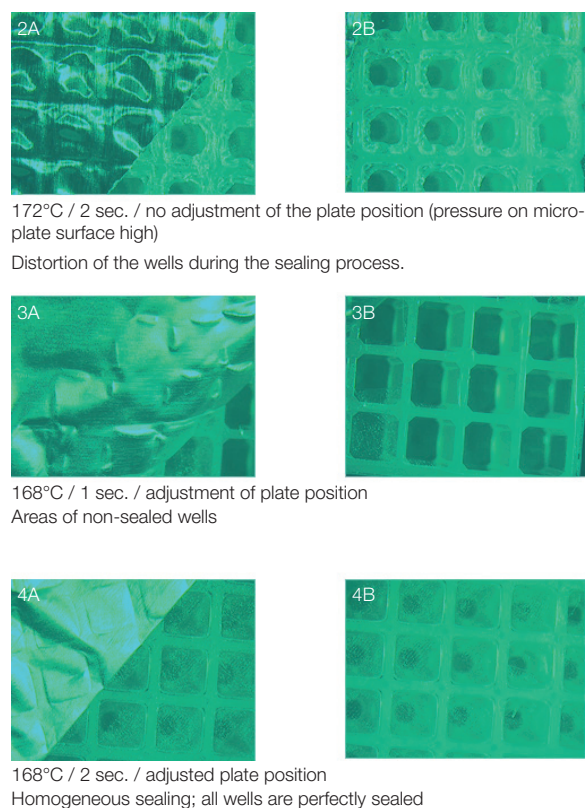

Figure 19: 384 Deep Well Small Volume™ microplate (# 784 201) sealed with different heat sealing devices under different sealing settings. The pictures in column A show the heat sealed microplate surface and the accompanying heat sealing film. The pictures in row B show the surface of heat sealed microplates.

## 4. Ordering Information

Cat.-No.	Description
650 201	96 Well, PP, U-bottom/ chimney well, natural
650 261	96 Well, PP, U-bottom/ chimney well, natural, sterile
650 207	96 Well, PP, U-bottom/ chimney well, white
650 209	96 Well, PP, U-bottom/ chimney well, black
655 201	96 Well, PP, F-bottom/ chimney well, natural
655 207	96 Well, PP, F-bottom/ chimney well, white
655 209	96 Well, PP, F-bottom/ chimney well, black
655 261	96 Well, PP, F-bottom, natural
651 201	96 Well, PP, V-bottom/ chimney well, natural
651 207	96 Well, PP, V-bottom/ chimney well, white
651 209	96 Well, PP, V-bottom/ chimney well, black
651 261	96 Well, PP, V-bottom, sterile
781 201	384 Well, PP, F-bottom, natural
781 207	384 Well, PP, F-bottom, white
781 209	384 Well, PP, F-bottom, black
781 280	384 Well, PP, V-bottom, natural
781 281	384 Well, PP, V-bottom, sterile
781 287	384 Well, PP, V-bottom, white
781 289	384 Well, PP, V-bottom, black
784 201	384 Deep Well Small Volume™, PP, natural
784 261	384 Deep Well Small Volume™, PP, natural, sterile
780 201	96 Well MASTERBLOCK®, PP, U-bottom, natural, 1 ml Volume/Well
780 206	96 Well MASTERBLOCK®, PP, U-bottom, yellow, 1 ml Volume/Well
780 215	96 Well MASTERBLOCK®, PP, U-bottom, natural, 1 ml Volume/Well
780 203	96 Well MASTERBLOCK®, PP, U-bottom, red, 1 ml Volume/Well
780 204	96 Well MASTERBLOCK®, PP, U-bottom, blue, 1 ml Volume/Well
780 205	96 Well MASTERBLOCK®, PP, U-bottom, green, 1 ml Volume/Well
780 210	96 Well MASTERBLOCK®, PP, 1 ml Volume/Well
780 261	96 Well MASTERBLOCK®, PP, U-bottom, natural, 1 ml Volume/Well, sterile
780 263	96 Well MASTERBLOCK®, PP, U-bottom, red, 1 ml Volume/Well, sterile
780 264	96 Well MASTERBLOCK®, PP, U-bottom, blue, 1 ml Volume/Well, sterile
780 265	96 Well MASTERBLOCK®, PP, U-bottom, green, 1 ml Volume/Well, sterile
780 266	96 Well MASTERBLOCK®, PP, U-bottom, yellow, 1 ml Volume/Well, sterile

Cat.-No.	Description
780 270	96 Well MASTERBLOCK®, PP, V-bottom, natural, 2 ml Volume/Well
780 271	96 Well MASTERBLOCK®, PP, V-bottom, natural, 2 ml Volume/Well, sterile
780 273	96 Well MASTERBLOCK®, PP, V-bottom, red, 2 ml Volume/Well, sterile
780 274	96 Well MASTERBLOCK®, PP, V-bottom, blue, 2 ml Volume/Well, sterile
780 275	96 Well MASTERBLOCK®, PP, V-bottom, green, 2 ml Volume/Well, sterile
780 276	96 Well MASTERBLOCK®, PP, V-bottom, yellow, 2 ml Volume/Well, sterile
780 280	96 Well MASTERBLOCK®, PP, 2 ml Volume/Well
780 285	96 Well MASTERBLOCK®, PP, V-bottom, natural, 2 ml Volume/Well
786 201	96 Well MASTERBLOCK®, PP, V-bottom, natural, 0.5 ml Volume/Well
786 261	96 Well MASTERBLOCK®, PP, V-bottom, natural, 0.5 ml Volume/Well, sterile
975 502	96 Well Storage Box, Polycarbonate
975 561	96 Well Storage Box, Polycarbonate, incl. 96 PP vessels, sterile
975 570	96 Well Storage Box, Polycarbonate, incl. 96 PP vessels
781 270	384 Well MASTERBLOCK®, PP, V-bottom, natural
781 271	384 Well MASTERBLOCK®, PP, V-bottom, natural, sterile
782 261	1536 Well MASTERBLOCK®, PP, V-bottom, natural, sterile
782 270	1536 Well MASTERBLOCK®, PP, V-bottom, natural

[www.gbo.com/bioscience](http://www.gbo.com/bioscience)

**Germany (Main office):** Greiner Bio-One GmbH, info@de.gbo.com | **Austria:** Greiner Bio-One GmbH, office@at.gbo.com  
**Belgium:** Greiner Bio-One BVBA/SPRL, info@be.gbo.com | **Brazil:** Greiner Bio-One Brasil, office@br.gbo.com  
**China:** Greiner Bio-One GmbH, info@cn.gbo.com | **France:** Greiner Bio-One SAS, infos@fr.gbo.com  
**Japan:** Greiner Bio-One Co. Ltd., info@jp.gbo.com | **Netherlands:** Greiner Bio-One B.V., info@nl.gbo.com  
**UK:** Greiner Bio-One Ltd., info@uk.gbo.com | **USA:** Greiner Bio-One North America Inc., info@us.gbo.com



greiner bio-one